

Množstvo **Popis**

1

MAGNA3 40-100 F

Poznámka: Obrázok produktu sa môže líšiť od skutočného produktu

Objednacie č.: 97924269

The Grundfos MAGNA3 circulator pump is the ideal choice for almost any building project – old or new. With its unrivalled energy efficiency, all-encompassing range and built-in communication capabilities, MAGNA3 is ideal for engineers and specifiers looking to create high-performance heating and cooling systems.

The pump is maintenance-free due to the canned-rotor type design. This also means that pump and motor form an integral unit without shaft seal and with only two gaskets for sealing. The bearings are lubricated by the pumped liquid.

MAGNA3 features an intuitive display and allows you to connect wirelessly with the Grundfos GO Remote app, giving you access to advanced reporting and monitoring.

MAGNA3 model E has Bluetooth, which allows you to connect directly to Grundfos Go app on your smart phone without any need for a dongle.

The pump includes fieldbus communication via CIM modules as well as analog and digital inputs and configurable relays.

Control features include AUTOADAPT and FLOWADAPT. FLOWADAPT which reduces the need for throttling valves, thus cutting costs on system components.

MAGNA3 is the superior choice for a wide range of heating and cooling applications, including:

- Mixing loops
- Heating surfaces
- Air conditioning surfaces
- Ground-source heat pump systems
- Smaller chiller applications.

MAGNA3 is a single-phase pump and characterised by having the controller and control display integrated in the control box. The pump also has a built-in differential-pressure and temperature sensor.

The pump housing is available in both cast-iron and stainless-steel versions. The composite rotor can be carbon-fibre reinforced, the bearing plate and rotor cladding are made of stainless steel and the stator housing is made of aluminium. The power electronics are air-cooled.

MAGNA3 incorporates a 4-pole synchronous, permanent-magnet motor (PM motor). This motor type is characterised by higher efficiency than a conventional asynchronous squirrel-cage motor. The pump speed is controlled by an integrated frequency converter.

97924269 MAGNA3 40-100 F

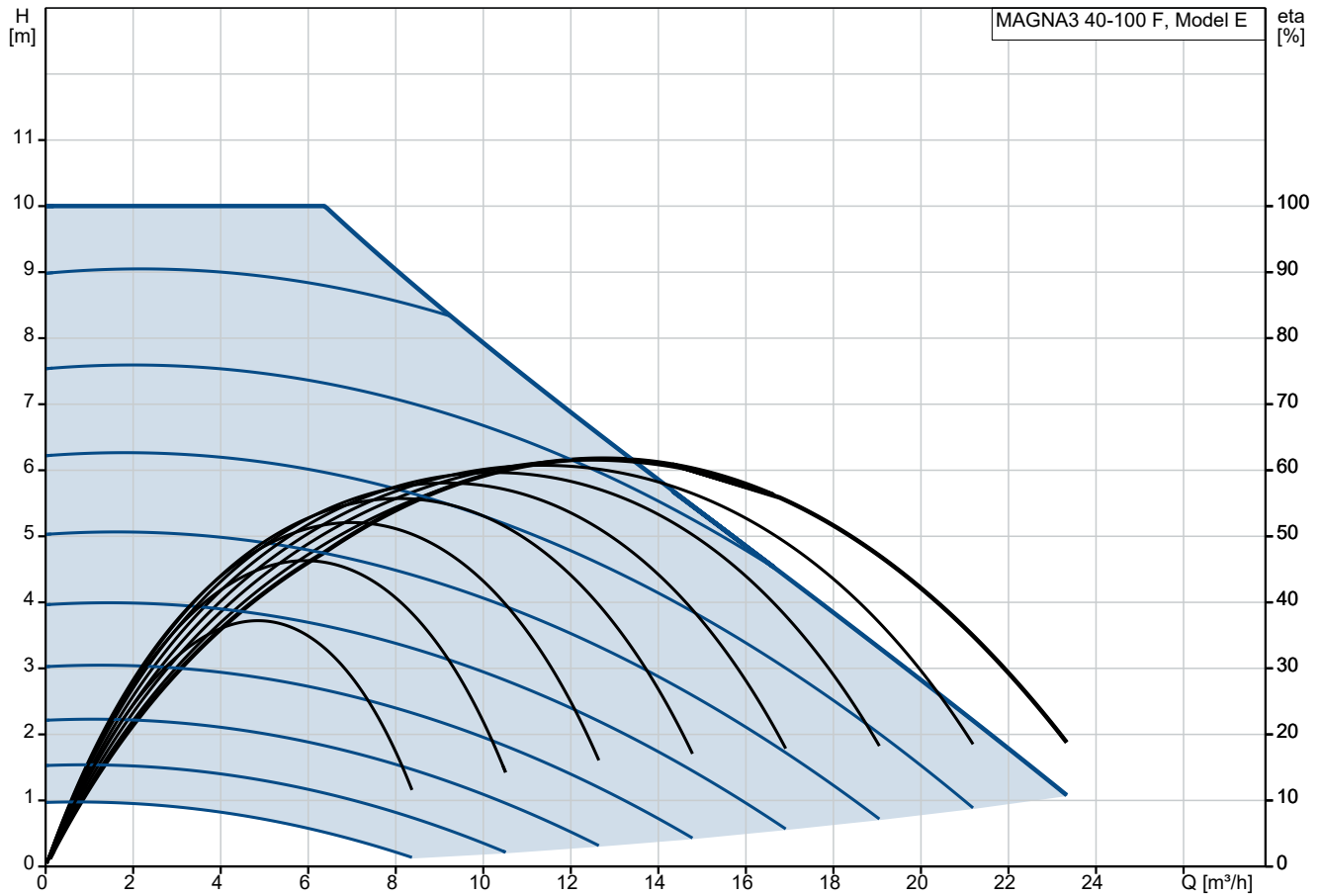

Čerpaná kvapalina = Voda
 Teplota kvapaliny počas prevádzky = 60 °C
 Hustota = 983.2 kg/m³

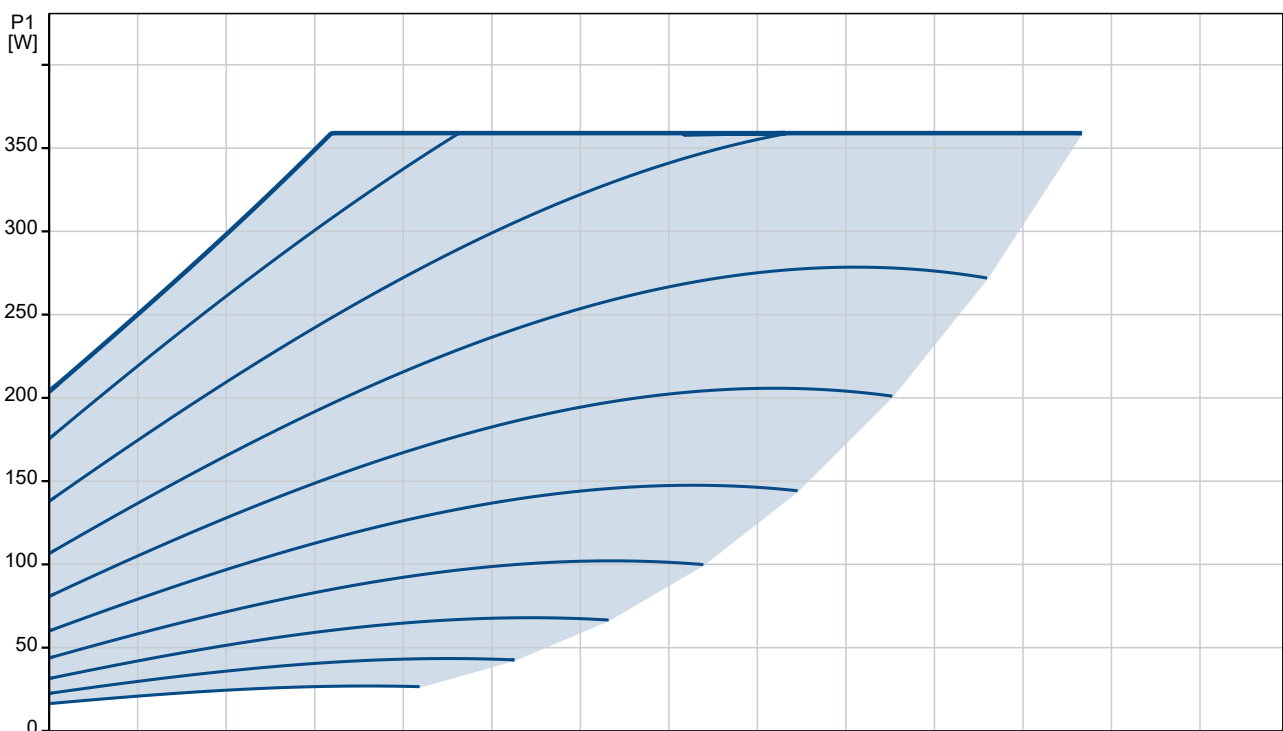

Popis	Hodnota
Všeobecné informácie:	
Názov produktu:	MAGNA3 40-100 F
Objednacie číslo:	97924269
Číslo EAN:	5710626493449
Cena:	EUR 2318
Techn.:	
Menovitý prietok:	12.16 m ³ /h
Men.dopravná výška:	6.797 m
Max. dopravná výška:	100 dm
Trieda TF:	110
Approvals:	CE, VDE, EAC, MOROCCO, UKCA, TSERCM, UkrSEPRO
Model:	E
Materiály:	
Teleso čerpadla:	Šedá liatina
Teleso čerpadla:	EN-GJL-250
Teleso čerpadla:	ASTM A48-250B
Obežné koleso:	PES 30%GF
Inštalácia:	
Rozsah teploty okolia:	0 .. 40 °C
Maximálny prevádzkový tlak:	10 bar
Štandardná príruha:	DIN
Potrubná prípojka:	DN 40
Hodnota tlaku:	PN 6/10
Vzdialenosť sac.-výtl.:	220 mm
Kvapalina:	
Čerpaná kvapalina:	Voda
Rozsah teploty kvapaliny:	-10 .. 110 °C
Vybraná teplota kvapaliny:	60 °C
Hustota:	983.2 kg/m ³
Elektrické údaje:	
Príkion - P1:	18 .. 359 W
f:	50 / 60 Hz
Menovité napätie:	1 x 230 V
I MAX:	0.2 .. 1.66 A
Krytie IP:	X4D
Izolácia:	F
Iné:	
Energia (EEI):	0.18
Čistá hmotnosť:	16.3 kg
Hrubá hmotnosť:	18.1 kg
Prepravné množstvo:	0.039 m ³
Dánčina:	380952410
Švédčina:	5732488
Fínčina:	4615147
Nórčina:	9042661
Krajina pôvodu:	DE
Tarifná klasifikácia č.:	84137030
Environmental approvals:	CN ROHS, WEEE

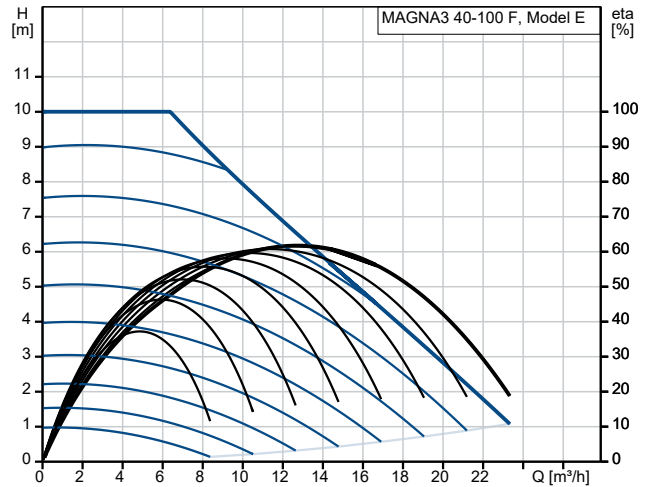

Čerpaná kvapalina = Voda
 Teplota kvapaliny počas prevádzky = 60 °C
 Hustota = 983.2 kg/m³

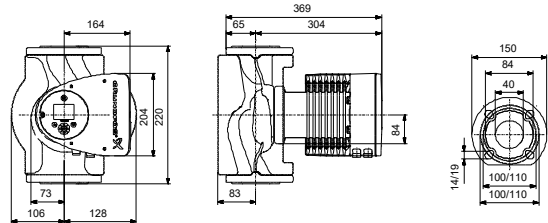
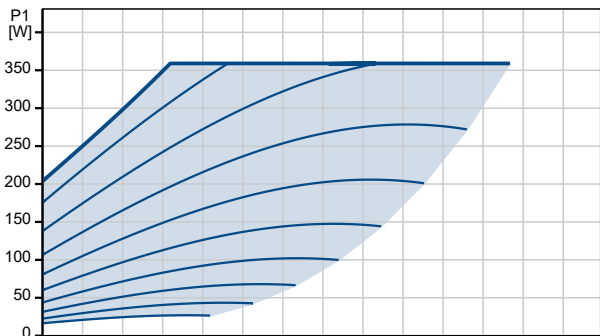

Example of mains-connected motor with mains switch, backup fuse and additional protection

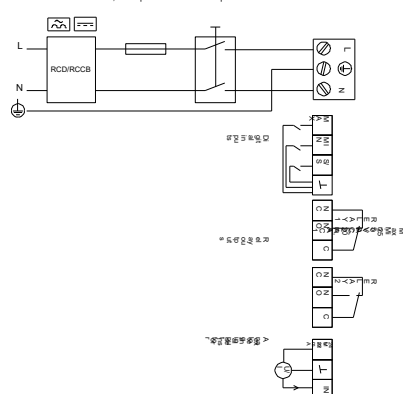

97924269 MAGNA3 40-100 F

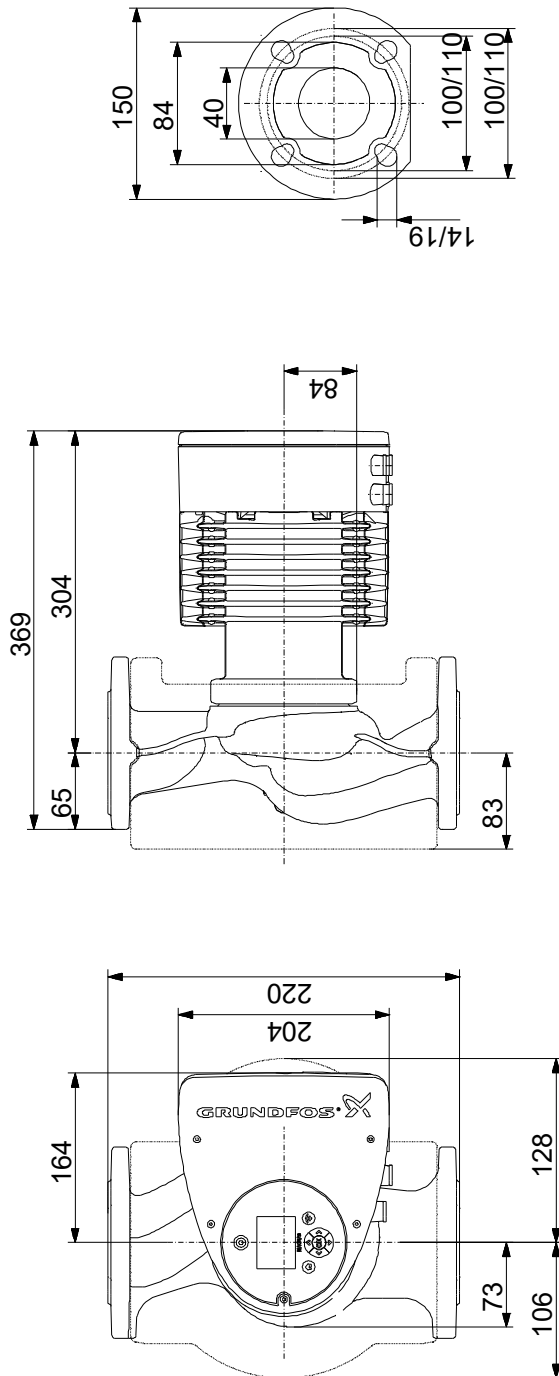

Upozornenie! Všetky jednotky musia byť v [mm], pokiaľ nie je uvedené inak.
Poznámka: Tento zjednodušený rozmerový náčrtok nezobrazuje všetky detaily.

97924269 MAGNA3 40-100 F

Example of mains-connected motor with mains switch, backup fuse and additional protection

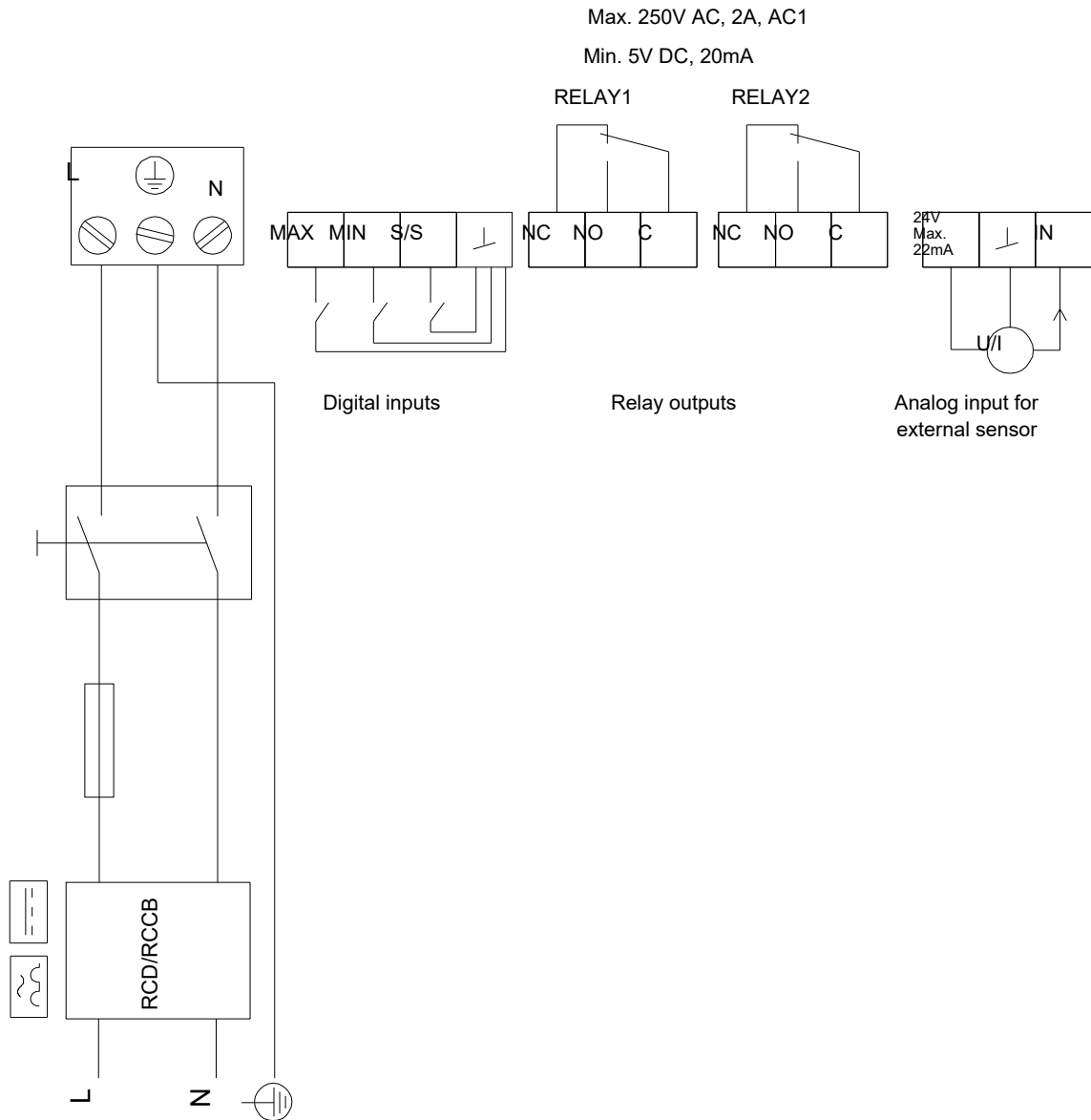

Upozornenie! Všetky jednotky sú v [mm], pokiaľ nie je uvedené inak!

